



 **Beta**

Special Motorbike catalogue

2018



www.beta-tools.com





Beta Utensili leads the way in the production of professional hand tools.

Beta's products are synonymous with unparalleled quality and reliability, as the result of eighty years of experience and tradition.

Our products are regularly updated, their quality being highly appreciated by the engineers and mechanics of the best racing teams in the Road Racing World Championship Grand Prix, Superbike World Championship, Motocross World Championship and World Enduro Championship.

Our ongoing commitment to excellence has had an impact on all the company processes and allowed us to have our Quality Systems certified in accordance with the ISO 9001 standard as early as 1995.

2018

The special Motorbike Catalogue is an accurate selection of products specially designed for the motorcycle industry.

General maintenance and controlled tightening tools, stands and jacks as well as several motorcycle items are available, the emphasis being on technical details. A useful abstract from a product range which exceeds 10,000 coded items, a must-have instrument for identifying the products that best satisfy the most demanding professionals' requirements.

50
years in Motorsports



Index



4÷13

Containers and assortments



36-37

Electric system

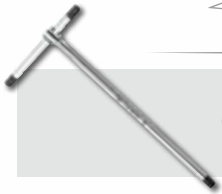

14÷29

General tools



38-39

Trasmission - Brakes - Suspensions



18-19

Controlled tightening



40÷43

Wheels



30-31

Diagnostics



44÷49

Stands and jacks



32÷34

Engine



50-51

Specialized equipment



34-35

Oil and filters

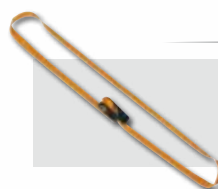

52÷54

Tie down systems

Portable tool chest



C22S

Portable tool chest with three drawers

- Three drawers (588x277 mm) with ball bearing slides:
 - 1 drawer, 50 mm high
 - 2 drawers, 70 mm high.
- Front centralized safety lock.
- Retractable side handles for ease of handling.



C22S-O	19 kg	022000501
C22S-G	19 kg	022000502
C22S-R	19 kg	022000503

h	max
50 mm	25 kg
70 mm	25 kg

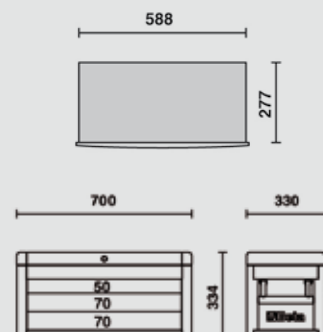

C23S

Portable tool chest with five drawers

- Five drawers (588x277 mm) with ball bearing slides:
 - 2 drawers, 50 mm high
 - 3 drawers, 70 mm high.
- Front centralized safety lock.
- Retractable side handles for ease of handling.



C23S-O	26 kg	023000501
C23S-G	26 kg	023000502
C23S-R	26 kg	023000503

h	max
50 mm	25 kg
70 mm	25 kg

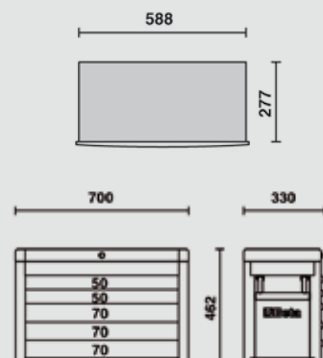

C23SC

Portable tool chest with eight drawers

- Eight drawers with ball bearing slides:
 - 4 drawers, 50 mm high
 - 3 drawers, 70 mm high
 - 1 drawer, 100 mm high.
- Front centralized safety lock.
- Retractable side handles for ease of transport.



C23SC-O	28 kg	023000511
C23SC-G	28 kg	023000512
C23SC-R	28 kg	023000513

h	max
50 mm	25 kg
70 mm	25 kg

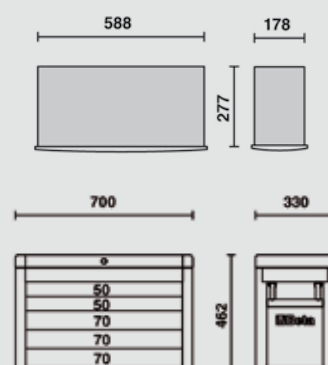

Mobile roller cab



C24S/5

Mobile roller cab with five drawers

- Five drawers (588x367 mm) with ball bearing slides:
 - 2 drawers, 70 mm high
 - 2 drawers, 140 mm high
 - 1 drawer, 280 mm high
- Drawer bases protected by foamed rubber mats.
- Four castors 125 mm in Ø:
 - 2 fixed and 2 steering (one with brake).
- Front centralized safety lock.
- Static load capacity: 800 kg.
- Thermoplastic worktop designed to match tool chests C22S, C23S, C23SC and C23ST
- Integrated side bottle holder.
- Paper roll holder item 2400S-R/PC can also be included.



h	max
70 mm	25 kg
140 mm	30 kg
280 mm	35 kg

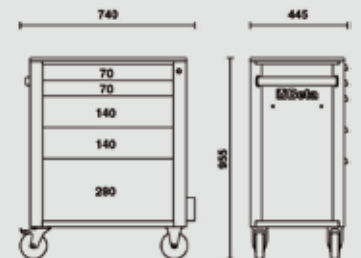
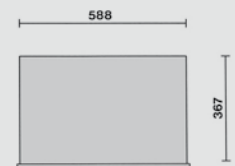

C24S/5-O	52 kg	024002051
C24S/5-G	52 kg	024002052
C24S/5-R	52 kg	024002053

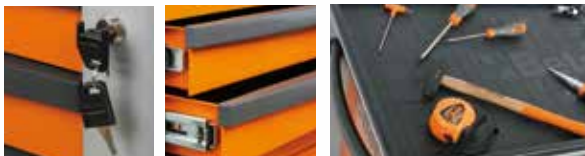

C24S/7

Mobile roller cab with seven drawers

- Seven drawers (588x367 mm) with ball bearing slides:
 - 5 drawers, 70 mm high
 - 1 drawer, 140 mm high
 - 1 drawer, 210 mm high
- Drawer bases protected by foamed rubber mats.
- Four castors 125 mm in Ø:
 - 2 fixed and 2 steering (one with brake).
- Front centralized safety lock.
- Static load capacity: 800 kg.
- Thermoplastic worktop designed to match tool chests C22S, C23S, C23SC and C23ST
- Integrated side bottle holder.
- Paper roll holder item 2400S-R/PC can also be included.



h	max
70 mm	25 kg
140 mm	30 kg
210 mm	30 kg

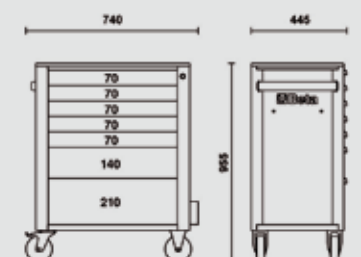
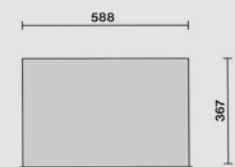

C24S/7-O	58 kg	024002071
C24S/7-G	58 kg	024002072
C24S/7-R	58 kg	024002073

Containers and assortments



C33/7

Mobile roller cab with seven drawers

- Seven drawers (588x367 mm) with ball bearing slides:
 - 5 drawers 75 mm high
 - 1 drawer 150 mm high
 - 1 drawer 225 mm high.
- Sturdy multi-purpose worktop.
- Tote-trays and holes for accommodating screwdrivers.
- Convenient "V" groove for working pipes and sections.
- Quick release system made of fibreglass-reinforced nylon, opening throughout length of drawer.
- Corner bumpers throughout height of roller cab, to avoid damaging vehicles in garage.
- Drawer bases protected by foamed rubber mats.
- Four castors Ø 125 mm:
 - 2 fixed and 2 steering (one with brake).
- Front centralized safety lock.
- Static load capacity: 1000 kg.
- Built-in side bottle and paper holders, adjustable in several positions.



C33/7-O	71 kg	033000271
C33/7-G	71 kg	033000272
C33/7-R	71 kg	033000273

h	max
75 mm	30 kg
150 mm	35 kg
225 mm	35 kg

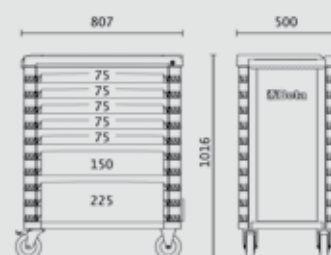

C33N limited edition



C27S

Folding tool trolley for outdoor jobs, empty

- Folding tool trolley. Its unique patented design guarantees an effortless transport.
- 2 drawers, 588x277 mm, with ball bearing slides for two-way opening.
- Large lower object compartment, 588x277x220 mm.
- Sheet metal frame.
- 2 fixed castors, Ø 160 mm, and 2 steering castors with brake, Ø 100 mm
- Thermoplastic worktop with 6 built-in tool trays.
- Centralized lock.
- **Can accommodate drawer partitions and MC foam tool trays**



C27S-O	20 kg	027000201
C27S-G	20 kg	027000202
C27S-R	20 kg	027000203

h	max
70 mm	20 kg

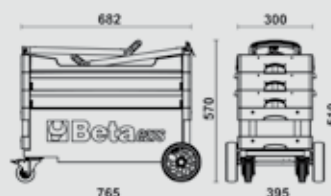
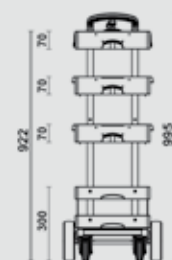
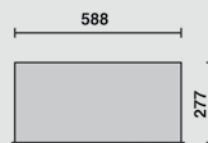

Tool trolley



C41S

Two-module tool trolley

- Sheet metal frame and plastic tops, synonymous with remarkable sturdiness and reduced weight.
- 2 detachable modules: 1 upper tool box, 1 module with 2 drawers, 95 mm and 295 mm high respectively.
- Oversized castors (160 mm), built into frame for easy transport - for example, on steps.
- Side centralized lock for closing drawers of lower module.
- Drawers with ball bearing slides and double closing hook.
- Telescopic aluminium handle.
- Small tool holder built into upper tool box.
- Lower drawer with double ballbearing slide



C41S 16 kg 041000001

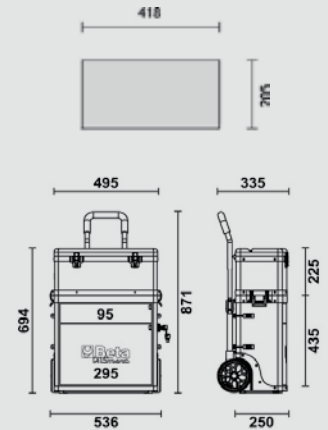

C41H

Two-module tool trolley

- Sheet metal frame and plastic tops, synonymous with remarkable sturdiness and reduced weight.
- 2 detachable modules: 1 upper tool box, 1 module with 2 drawers 95 mm in height, 1 pull-out case made of plastic, 66 mm high, and 1 drawer 295 mm in height.
- Oversized castors (160 mm), built into frame for easy transport - for example, on steps.
- Side centralized lock for closing drawers of lower module.
- Drawers with ball bearing slides and double closing hook.
- Telescopic aluminium handle.
- Small tool holder built into upper tool box.
- Lower drawer with double ballbearing slide



C41H 21 kg 041000002

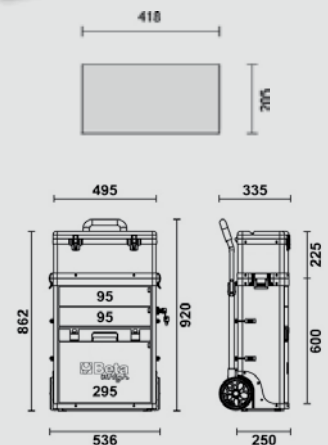

* Colours available on request



Containers and assortments



C51

Trolley

- 3 tops covered in antislip ribbed rubber
- Ergonomic handle
- Two fixing options for central worktop
- Four castors Ø 100 mm:
2 fixed and 2 steering (1 with brake)
- Static load capacity: 200 kg
(distributed between 3 shelves)



	Weight	Code
C51-O	21 kg	051000001
C51-G	21 kg	051000002
C51-R	21 kg	051000003

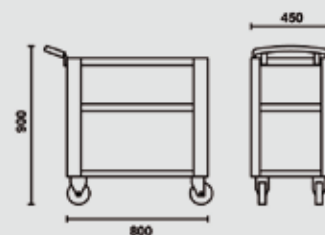

C56

Workbench

- Worktop made of painted sheet metal with external edge
- Steel frame with 6 supporting legs
- Static load capacity: 1200 kg
- Matches panel toolholder C57P; cannot be fixed to worktop
- Two drawers with lock
- Can be fixed to floor

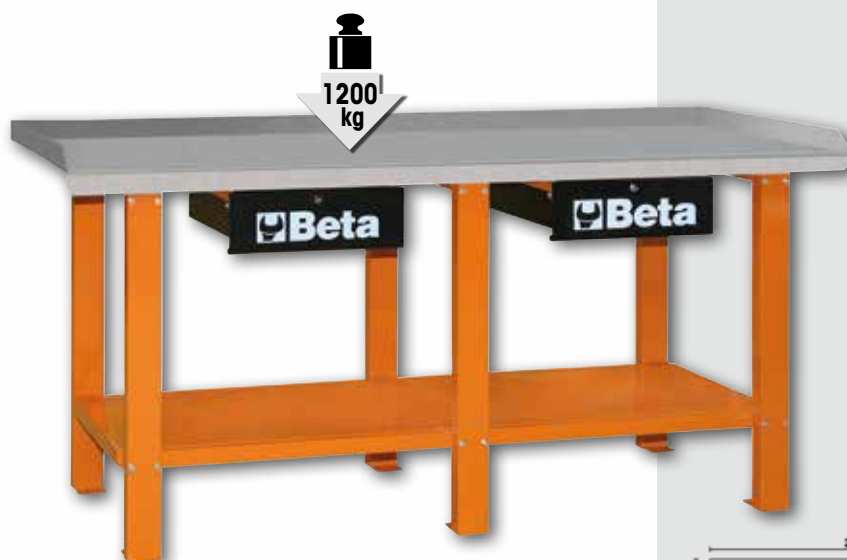

	Weight	Code
C56-O	82 kg	056000201
C56-G	82 kg	056000202
C56-R	82 kg	056000203



Special mobile roller cab

- Multi-ply wood worktop
- Front centralized safety lock
- 4 castors, Ø 125 mm: 2 fixed and 2 steering (one with brake), with exposed covering
- Static load capacity: 1200 kg



C39SM

Special mobile roller cab, Racing SM type

7-drawer module 588x367 mm, with ball bearing slides:

- 6 drawers, 70 mm high
- 1 drawer, 240 mm high
- Drawer bases protected by foamed rubber mats
- Front centralized safety lock
- Opening system throughout length of drawer
- Drawer front made of aluminium

Service module

- Integrated wastepaper basket
- Paper roll compartment
- 1 large drawer (420x305x270 mm)



h	max
70 mm	30 kg
240 mm	40 kg

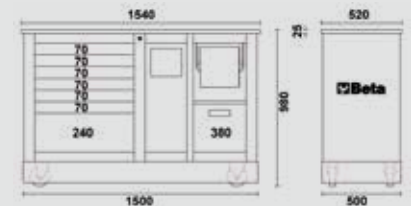
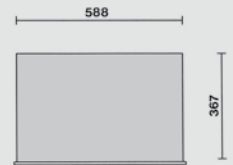

C39SM-O	125 kg	039390001
C39SM-G	125 kg	039390002
C39SM-R	125 kg	039390003



C39MD

Special mobile roller cab, Racing MD type

7-drawer module 588x367 mm, with ball bearing slides:

- 6 drawers, 70 mm high
- 1 drawer, 240 mm high
- Drawer bases protected by foamed rubber mats
- Front centralized safety lock
- Opening system throughout length of drawer
- Drawer front made of aluminium

2-drawer module 588x367x270 mm and 588x367x380 mm, with ball bearing slides

- Drawer bases protected by foamed rubber mats
- Front centralized lock
- Opening system throughout length of drawers
- Drawer front made of aluminium



h	max
70 mm	30 kg
240 mm	40 kg

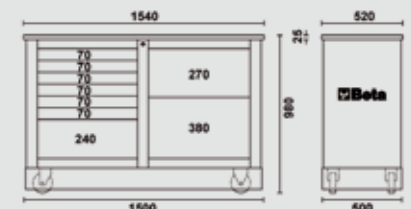
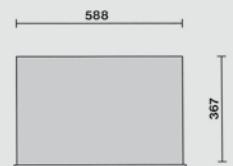

C39MD-O	123 kg	039390101
C39MD-G	123 kg	039390102
C39MD-R	123 kg	039390103

Containers and assortments



5904VG/2M

Assortment of 170 tools



M15 M16 VP/M3



M50 M55 M86



M208 M85 M234



M83 M131 M145

For mobile roller cabs
C24S and C33



Quantity/Description

16	combination wrenches 6+21 mm	42	M15
5	combination wrenches 22 - 24 - 27 - 30 - 32 mm	42	M16
8	offset hexagon key wrenches \odot 2-2,5-3-4-5-6-7-8 mm	96T	M50
6	drivers for Torx® head screws, with handles \odot T10-T15-T20-T25-T27-T30	97TTX	M55
7	hexagon bits \odot 4-5-6-7-8-10-12 mm	867PE	M86
7	hexagon bits \odot 4-5-6-7-8-10-12 mm	867PE/L	M86
5	bits with XZN® profile \odot 5-6-8-10-12 mm	867XZN	M86
5	bits with XZN® profile \odot 5-6-8-10-12 mm	867XZN/L	M86
7	bits for Torx® head screws \odot T20-T25-T30-T40-T45-T50-T55	867TX	M86
6	bits for Torx® head screws \odot T25-T30-T40-T45-T50-T55	867TX/L	M86
7	bits for Tamper Resistant Torx® head screws \oplus T20-T25-T30-T40-T45-T50-T55	867RTX	M86
1	bit holder sockets for item 867	867/1	M86
1	bit holder sockets for item 867	867/2	M86
5	screwdrivers for cross head Phillips® screws \bullet 3x75 - 4x100 - 4x125 - 5,5x150 - 6,5x150 mm	1260	M208
3	screwdrivers for cross head Phillips® screws \oplus PH0x60 - PH1x80 - PH2x100 mm	1262	M208
1	screwdrivers for slotted head screws, extra-short series \bullet 4x30 mm	1260N	M208
1	screwdrivers for cross head Phillips® screws, extra - short series \oplus PH1x30 mm	1262N	M208
5	bits for slotted head screws, coloured \bullet 0,5x3 - 0,6x4,5 - 0,8x5,5 - 1x5,5 - 1,2x6,5 mm	860LP	M85
8	hexagon bits for power drivers, coloured \odot 2 - 2,5 - 3 - 4 - 5 - 6 - 8 - 10 mm	860PE	M85
5	bits for cross head Phillips® screws, coloured \oplus PH0 - PH1 - PH2 - PH3 - PH4	860PH	M85

Beta N. TR

Quantity/Description

4	bits for cross head Pozidriv® - Supadriv® screws, coloured \oplus PZ1 - PZ2 - PZ3 - PZ4	860PZ	M85
10	bits for Torx® head screws, coloured \odot T7-T8-T9-T10-T15-T20-T25-T27-T30-T40	860TX	M85
8	bits for Tamper Resistant Torx® head screws, coloured \oplus T9-T10-T15-T20-T25-T27-T30-T40	860RTX	M85
1	magnetic bit holder with handle 230 mm	851SR	M85
1	reversible bit ratchet 100 mm	860/55	M85
2	flat chisels, ribbed type 100 - 200 mm	35	M234
1	engineer's hammer 300 g	1370	M234
1	soft face hammer \varnothing 35 mm	1390	M234
1	1/2" wobble extension bar 125 mm	920AN/125	M83
1	1/2" wobble extension bar 250 mm	920AN/250	M83
1	1/2" drive universal joint	920/25	M83
1	1/2" drive sliding T-handle	920/42	M83
1	1/2" drive reversible ratchet \oplus	920/55	M83
19	1/2" square drive hexagon sockets \odot 10+24 - 26 - 27 - 30 - 32 mm	920A	M83
1	half-round needle nose pliers 180 mm	1150BM	M131
1	extra long needle knurled nose pliers, bi-material handles \bullet 160 mm	1166BM	M131
1	heavy duty diagonal cutting nippers ∇ 160 mm	1084BM	M131
1	circlip pliers straight, internal \odot 180 mm	1032	M145
1	circlip pliers bent, internal \odot 170 mm	1034	M145
1	circlip pliers straight, external \bullet 175 mm	1036	M145
1	circlip pliers bent, external \bullet 175 mm	1038	M145
1	soft thermoformed tray	VP/M3	



5904VG/2M 17 kg 059040198



5940SBK

Assortment of 125 tools



Quantity/Description

- 1 drift punches Ø 2 mm
- 1 centre punch Ø 4 mm
- 1 flat chisels 125 mm
- 10 combination wrenches 6 - 7 - 8 - 10 - 11 - 12 - 13 - 14 - 17 - 19 mm
- 6 double open end wrenches 6x7 - 8x9 - 10x11 - 12x13 - 14x15 - 16x17 mm
- 9 offset hexagon key wrenches \odot 1,5 - 2 - 2,5 - 3 - 4 - 5 - 6 - 8 - 10 mm
- 1 click type torque wrench 3/8", 8+60 Nm
- 54 assortment of 52 hexagon bits, 10 mm, and 2 accessories
- 17 assortment of 12 sockets and 5 accessories
- 1 adaptor, 1/2" female and 3/8" male drives
- 2 3/8" square drive spark plug sockets \odot 16 - 17,8 mm
- 1 extra - long nose pliers \bullet 283 mm
- 2 circlip pliers straight, internal \odot 140 - 180 mm
- 1 circlip pliers straight, external \bullet 140x1,3 mm
- 1 diagonal cutting nippers \sphericalangle 160 mm
- 1 electrician's scissors, straight blades
- 1 half-round needle nose pliers \equiv 180 mm
- 1 screwdriver for Dzus® head screws \bullet
- 4 screwdrivers for cross head Phillips® screws \bullet 3x75 - 4x100 - 5,5x100 - 6,5x150 mm
- 3 screwdrivers for cross head Phillips® screws \bullet PH0x60 - PH1x80 - PH2x100 mm
- 1 circuit testing screwdriver \bullet
- 1 engineer's hammer 300 g
- 1 adjustable oil filter wrench
- 1 metric feeler gauge
- 1 mini hacksaw frame
- 1 brush, brass wires
- 1 plastic oil can 250 cc

Beta N.

- 30
- 32
- 34
- 42
- 55
- 96/SC9
- 606/6
- 867/C52
- 920A/C12X
- 910/16
- 956E
- 1009L/A
- 1032
- 1036
- 1082
- 1128BM
- 1150
- 1201DZ
- 1201
- 1202
- 1254
- 1370
- 1491
- 1708/13
- 1725CR
- 1737
- 1754

For C41S and C41H



5940SBK 13 kg 059400081

34 MC10



- 42 6-7-8-9-10-11-12-13-14-15-16-17-18-19-21-22 mm
- 96/SC9 1,5-2-2,5-3-4-5-6-8-10 mm
- 1084BM 160 mm
- 1150BM 180 mm
- 1166BM 160 mm
- 1201 3,5x100-5,5x150-6,5x150 mm
- 1202 PH0x60-PH1x80-PH2x100 mm

3,5 kg 027500010

74 MC20



- | | |
|---|---|
| 860MIX/A31 | 900BG/30C |
| 895/1 | 900/42 |
| 1048 250 mm | 900/55 |
| 1370 300 g | 920A 10-11-12-13-14-15-16-17-18-19-21-22-24-27-30-32 mm |
| 32 Ø 4 mm | 920/25 |
| 36 Ø 4 mm | 920AN/125 125 mm |
| 900 4-4,5-5-5,5-6-7-8-9-10-11-12-13-14 mm | 920/42 |
| 900/21 150 mm | 920/55 |
| 900/25 | |

6 kg 027500020

16 M15



- 42 6-7-8-9-10-11-12-13-14-15-16-17-18-19-20-21 mm

1,5 kg 024500015

17 M33



- 55 6x7-8x9-10x11-12x13-14x15-16x17-18x19-20x22 mm
- 96/SC9 1,5+10 mm

1,1 kg 024500033

12 M46



- 142SN 8-9-10-11-12-13-14-15-16-17-18-19 mm

1,4 kg 024500046

8 M50



- 96T 2-2,5-3-4-5-6-7-8 mm

1,1 kg 024500050

5 M55



- 97TTX T10-T15-T20-T25-T30

330 g 024500055

16 M65

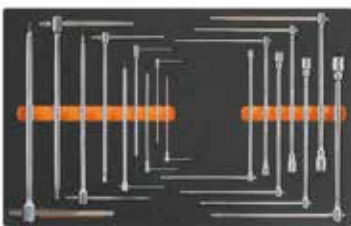

- 950 8-10-12-13-14-17-19 mm
- 951 2,5-3-4-5-6-8-10-12-14 mm

3,6 kg 024500065

9 M69

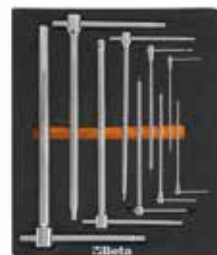

- 951 2,5-3-4-5-6-8-10-12-14 mm

1,8 kg 024500069

24 M83



- 12"
- 920A 10-11-12-13-14-15-16-17-18-19-20-21-22-23-24-26-27-30-32 mm
 - 920AN/125 125 mm
 - 920AN/250 250 mm
 - 920/25 255 mm
 - 920/42 305 mm
 - 920/55

3,7 kg 024500083

45 M85



- 1 1/4"
- 851SR 230 mm
 - 860LP 0,5x3 - 0,6x4,5 - 0,8x5,5 - 1x5,5 - 1,2x6,5 mm
 - 860PE 2 - 2,5 - 3 - 4 - 5 - 6 - 8 - 10 mm
 - ⊕860PH PH0 - PH1 - PH2 - PH3 - PH4
 - ⊕860PZ PZ1 - PZ2 - PZ3 - PZ4
 - ⊕860TX T6-T7-T8-T9-T10-T15-T20-T25-T27-T30-T40
 - ⊕860RTX T9-T10-T15-T20-T25-T27-T30-T40
 - 860/55 100 mm
 - 882P 80 mm

450 g 024500085

46 M86



- 10 mm
- 867PE 4-5-6-7-8-10-12 mm
 - 867PE/L 4-5-6-7-8-10-12 mm
 - 867XZN 5-6-8-10-12 mm
 - 867XZN/L 5-6-8-10-12 mm
 - ⊕867TX T20-T25-T30-T40-T45-T50-T55
 - ⊕867TX/L T25-T30-T40-T45-T50-T55
 - ⊕867RTX T20-T25-T30-T40-T45-T50-T55

867/1
867/2
 1,4 kg 024500086

25 M91



- 14"
- 900 4-4,5-5-5,5-6-7-8-9-10-11-12-13-14 mm
 - 900ME 2,5-3-4-5-6-8 mm
 - 900/20 50 mm
 - 900/21 150 mm
 - 900/25 □ 1/4 - ■ 1/4
 - 900BG/30
 - 900/42
 - ⊕900/55

560 g 024500091

22 M92

38



- 910A 6-7-8-9-10-11-12-13-14-15-16-17-18-19-20-21-22 mm
- 910/21 125 mm
- 910/22 250 mm
- 910/25
- 910/42
- 910/55

1,5 kg 024500092

98 M100

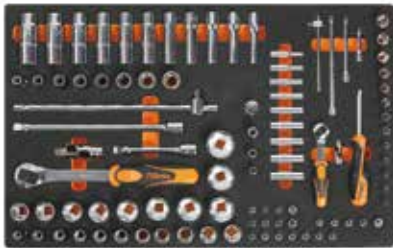

- 895/1
- 895/3
- 895/6
- 900 4-4,5-5-5,5-6-7-8-9-10-11-12-13-14 mm
- 900L 5-6-7-8-9-10-11-12-13 mm
- 900ME 3-4-5-6-7 mm
- 900LP 0,8x4-1x5,5-1,2x6,5-1,2x8 mm
- 900PH PH1-PH2-PH3-PH4
- 900TX T10-T15-T20-T25-T27-T30-T40
- 900/20 50 mm
- 900/20L 100 mm
- 900/21 150 mm
- 900/25
- 900BG/30
- 900/42
- 900/55
- 920A 8-10-11-12-13-14-15-16-17-18-19-20-21-22-23-24-26-27-28-30-32 mm
- 920/15
- 920/25
- 920AN/125 125 mm
- 920AN/250 250 mm
- 920/42
- 920/55
- 920FTX 10-12-14-16-18-20-22-24 mm
- 920AL 10-12-13-14-15-16-17-18-19-21-22 mm

6,7 kg 024500100

13 M130



- 1032 180 mm
- 1034 170 mm
- 1036 175 mm
- 1038 175 mm
- 1048 250 mm
- 1052 240 mm
- 1082BM 160 mm
- 1098 220 mm
- 1112 250 mm
- 1128BM
- 1150BM 180 mm
- 1166BM 160 mm
- 1168BM 160 mm

3,4 kg 024500130

3 M131



- 1084BM 160 mm
- 1150BM 180 mm
- 1166BM 160 mm

750 g 024500131

4 M145



- 1032 180 mm
- 1034 170 mm
- 1036 175 mm
- 1038 175 mm

640 g 024500145

2 M153



- 1048 250 mm
- 1052 240 mm

1 kg 024500153

6 M204



- 1267TX T8-T10-T15-T20-T25-T30

450 g 024500204

10 M208

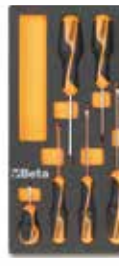

- 1260 3x75 - 3,5x100
4x125 - 5,5x150
6,5x150 mm
- 1262 PH0x60
PH1x80
PH2x100 mm
- 1260N 4x30 mm
- 1262N PH1x30 mm

750 g 024500208

25 M210



- 1201 2,5x50-3x75-4x100-5,5x125-6,5x150-8x200 mm
- 1201N 4x30 mm
- 1202 PH0x60-PH1x80-PH2x100-PH3x150 mm
- 1202N PH1x30 mm
- 1207TX T6-T7-T8-T9-T10-T15-T20-T25-T27-T30-T40-T45
- 1253

1,8 kg 024500210

25 M230



- 30 Ø 2-3-4 mm
- 31 Ø 2-3-4-5-6-8 mm
- 32 Ø 4 mm
- 34 150 mm
- 35 200-250 mm
- 36 125 mm
- 1370 500 g
- 1390 Ø 35 mm
- 1692 3 m
- 1712TF
- 1771 18 mm
- 1719BMA/Q 200 mm
- 1719BMA/T 200 mm
- 1719BMA/P 200 mm
- 1719BMA/M 200 mm
- 1719BMA/R 200 mm
- 1737NX
- 1771 18 mm

3,2 kg 024500230

4 M234



- 35 100-200 mm
- 1370 300 g
- 1390 Ø 35 mm

1,3 kg 024500234



1281BG/B28A

1/4"

Assortment of
16 reversible screwdrivers,
9 1/4" drive sockets,
2 accessories and 1 handle,
in wallet



	900	4 - 4,5 - 5 - 5,5 6 - 7 - 8 - 9 - 10 mm
	1281BG	
	1281PB	■ 1/4
	900/25	
	1281LP/1	0,8x4 - 1,2x6,5 mm
	1281LP/2	1,0x5,5 - 1,2x6,5 mm
	1281PH/1	PH1 - PH2
	1281PH/2	PH2 - PH3
	1281PZ/1	PZ1 - PZ2
	1281PZ/2	PZ2 - PZ3
	1281PE	2,5 - 3 - 4 - 5 - 6 mm
	1281TX/1	T6 - T8
	1281TX/2	T7 - T9
	1281RTX/3	T10 - T15
	1281RTX/4	T20 - T25
	1281RTX/5	T30 - T40

1281BG/B28A 1,1 kg 012810510



1281BG-TX/A8

1/4"

Assortment of
8 reversible screwdrivers
and 1 accessory,
in case



	1281BG	
	1281LPH/1	PH0-0,8x4 mm
	1281LPH/2	PH1-1x5,5 mm
	1281LPH/3	PH2-1,2x6,5 mm
	1281TX/1	T6-T8
	1281TX/2	T7-T9
	1281TX/3	T10-T15
	1281TX/4	T20-T25
	1281TX/5	T30-T40

1281BG-TX/A8 527 g 012810530



1281BG/A9

1/4"

Assortment of
9 reversible screwdrivers
and 1 accessory,
in case



	1281BG	
	1281LPH/1	PH0-0,8x4 mm
	1281LPH/2	PH1-1x5,5 mm
	1281LPH/3	PH2-1,2x6,5 mm
	1281PZ/1	PZ1-PZ2
	1281PE	2,5 mm
	1281PE	3 mm
	1281PE	4 mm
	1281PE	5 mm
	1281PE	6 mm

1281BG/A9 567 g 012810520

Wrenches



950

T-handle hexagon socket wrenches

- Sliding handle, which can be stopped in the required position throughout its length.
- Safety catch, which prevents the handle from coming out, thereby avoiding accidents.
- Triple size marking on head.

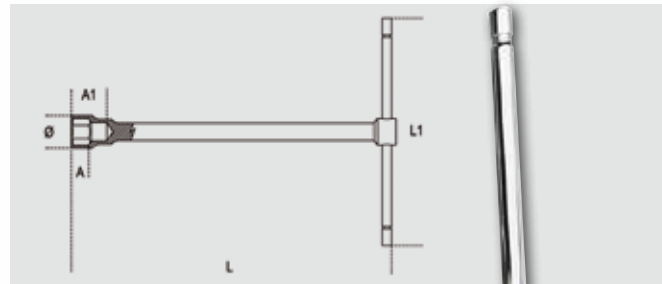

UNI 6742 DIN 3112

mm	L mm	Ø mm	L1 mm	A mm	A1 mm	g		mm	L mm	Ø mm	L1 mm	A mm	A1 mm	g	
6	210	10,1	145	5,0	16,0	98	009500006	14	250	20,1	190	11,5	25,0	289	009500014
7	212	11,2	145	6,0	18,0	100	009500007	15	254	21,5	190	12,0	25,0	307	009500015
8	220	12,4	160	7,0	19,0	140	009500008	16	260	22,7	200	12,5	26,0	414	009500016
9	223	13,5	160	8,0	20,0	142	009500009	17	264	24,1	200	13,0	27,0	436	009500017
10	230	14,9	160	8,5	21,0	172	009500010	19	274	26,6	230	14,5	29,0	553	009500019
11	233	16,1	160	9,0	22,0	176	009500011	22	290	29,9	290	16,0	32,0	797	009500022
12	240	17,5	175	9,5	23,0	228	009500012	24	300	32,2	320	18,0	36,0	976	009500024
13	244	19,7	175	10,5	24,0	233	009500013	27	315	36,2	370	21,0	42,0	1265	009500027

Set of T-handle hexagon socket wrenches

950/S9

7-8-10-11-12-13-14-17-19 mm 2,3 kg 009500079

950/I4

6-7-8-9-10-11-12-13-14-15-16-17-19-22 mm 4,1 kg 009500082



951

T-handle wrenches with three hexagon male ends

- Designed to develop high pairs.
- Calibrated hexagonal ends.
- The sliding block can be stopped in the desired position through the whole length; the safety clutches retain the shafts thus preventing any accidents

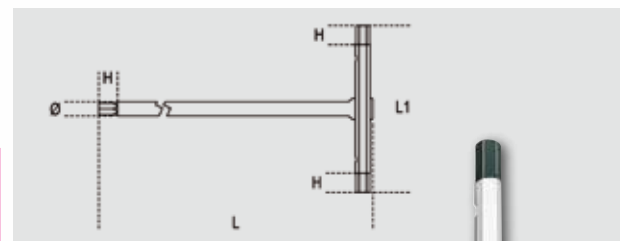

mm	L mm	L1 mm	Ø mm	H mm	g		mm	L mm	L1 mm	Ø mm	H mm	g	
2	125	63	4,0	5,5	20	009510521	6	215	99	8,0	10	117	009510560
2,5	150	63	4,0	6	20	009510525	7	230	109	9,0	11	163	009510570
3	150	63	4,0	6,5	22	009510530	8	250	122	10,0	12	219	009510580
3,5	175	76	5,5	7,5	46	009510535	9	265	132	11,0	13	289	009510590
4	175	76	5,5	8	47	009510540	10	280	142	12,0	14	371	009510610
4,5	195	87	6,5	8,5	75	009510545	12	305	160	15,0	15	613	009510620
5	195	87	6,5	9	76	009510550	14	330	178	17,0	17	884	009510640

General tools

Set of T-handle wrenches with three hexagon male ends

951/S8

2-2,5-3-3-3-5-4-4-5-5-6 mm

400 g 009510693

951/S14

2-2,5-3-3-3,5-4-4-4,5-5-6-7-8-9-10-12-14 mm

3,1 kg 009510695

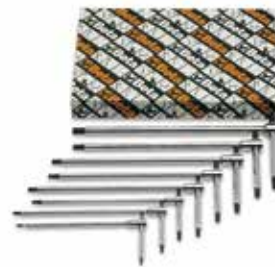

951TX

T-handle wrenches with three male ends for Torx® head screws

- Designed to develop high pairs.
- Calibrated hexagonal ends.
- The sliding block can be stopped in the desired position through the whole length; the safety clutches retain the shafts thus preventing any accidents

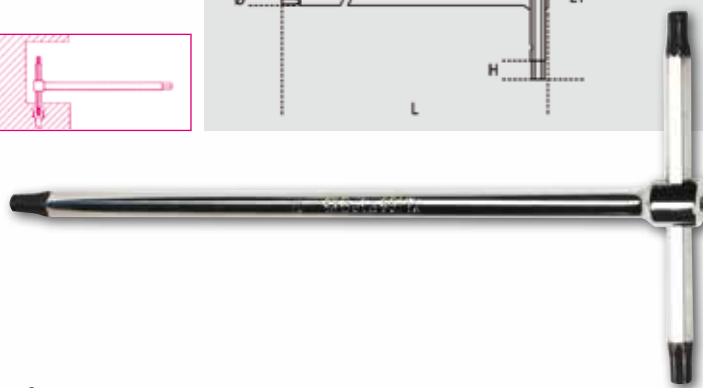
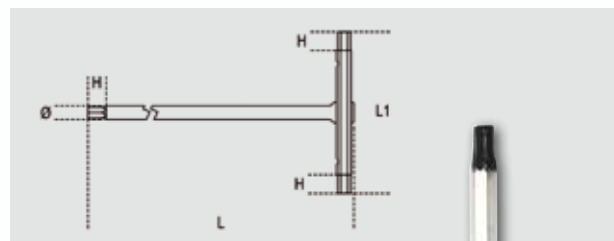

Ø	L mm	L1 mm	Ø mm	H mm	g	
T6	125	63	4	3,5	20	009510806
T7	125	63	4	3,5	20	009510807
T8	125	63	4	3,5	20	009510808
T9	125	63	4	3,5	20	009510809
T10	150	63	4	4	23	009510810
T15	150	63	4	4,2	22	009510815
T20	175	76	5	4,5	46	009510820

Ø	L mm	L1 mm	Ø mm	H mm	g	
T25	175	76	5	5	47	009510825
T27	195	87	6	5,5	74	009510827
T30	195	87	6	6,3	75	009510830
T40	215	99	7	6,5	115	009510840
T45	230	109	8	7,5	159	009510845
T50	250	122	9	9	215	009510850

Set of offset key wrenches for Torx® head screws

951TX/S6

T8-T10-T15-T20-T25-T30

0,5 kg 009510866

951TX/S13

T6-T7-T8-T9-T10-T15-T20-T25-T27-T30-T40-T45-T50

1 kg 009510863

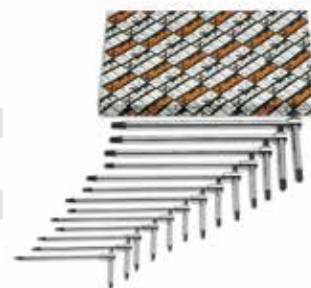

Sockets and accessories



860/C27

Assortment of 25 bits, 1 connector and 1 reversible ratchet in plastic case



	860/55	100 mm
	860LP	0,5x3-1,0x5,5-1,2x6,5 mm
	860PH	PH1-PH2(x2)-PH3
	860PZ	PZ1-PZ2(x2)-PZ3
	860PE	2-2,5-3-4-5-6 mm
	860TX	T6-T8-T10-T15-T20-T25-T30-T40
	892/0	● 1/4 ■ 1/4

150x95x50 mm 860/C27 785 g 008600880



900/C39

Assortment of
11 hexagon sockets,
21 bits and 7 accessories
in plastic case



1/4" 1/4"

	861LP	0,6x4,5-1,2x6,5-1,2x8 mm
	861PH	PH1-PH2-PH3
	861PZ	PZ1-PZ2-PZ3
	861PE	2,5-3-4-5-6 mm
	861RTX	T10-T15-T20-T25-T27-T30-T40
	900	5-5,5-6-7-8-9-10-11-12-13-14 mm
	900/20	50 mm
	900/20L	100 mm
	900/25	
	900BG/30C	
	900/55	
	892/0	
	895/1	

150x95x50 mm 900/C39 785 g 009000937



900/C12MR

Assortment of
12 hexagon sockets,
20 bits and 7 accessories
in foam tray,
in metal case

- Reversible ratchet with rotating handle



1/4" 1/4"

	861LP	0,5x3-0,8x5,5-1x5,5-1,2x6,5 mm
	861PE	3-4-5-6-8 mm
	861PH	PH0-PH1-PH2-PH3
	861TX	T8-T10-T15-T20-T25-T30-T40
	895/1	□1/4" - □1/4"
	900	4-5-5,5-6-7-8-9-10-11-12-13-14 mm
	900/20	50 mm
	900/21	150 mm
	900/25	
	900/42	
	900BG/30	
	900/58	

350x150x50 mm 900/C12MR 1,3 kg 009000962



910A/C16HR

Assortment of
16 hexagon sockets
and 5 accessories,
in metal case

- Reversible ratchet with rotating handle



3/8"

	910A	6-7-8-9-10-11-12-13-14-15-16-17-18-19-21-22 mm
	910/21	125 mm
	910/22	250 mm
	910/25	
	910/42	
	910/58	

335x145x60 mm 910A/C16HR 2,4 kg 009100935



920A/C17MR

Assortment of
17 hexagon sockets
and 5 accessories
in foam tray,
in metal case

- Reversible ratchet with rotating handle



1/2"

	920A	10-11-12-13-14-15-16-17-18-19-20-21-22-24-27-30-32 mm
	920/21	125 mm
	920/22	255 mm
	920/25	
	920/42	
	920/58	

420x185x60 mm 920A/C17MR 5,1 kg 009200937

General tools



941

Hexagon / bi-hex socket wrenches,
with high torque handles

- Deep, hi-torque hexagon nut spinner on long side

mm	L mm	L1 mm	A1 mm	A mm	S mm	A2 mm	A3 mm	Ø mm	g	
7x7	200	91	35	6,0	20,6	15,5	6,0	11,0	104	009410107
8x8	220	107	50	7,0	25,2	18,5	7,0	12,2	151	009410108
9x9	220	109	50	8,0	25,2	19,5	8,0	13,5	163	009410109
10x10	236	111	50	8,5	25,2	20,5	8,5	15,0	194	009410110
11x11	236	114	50	9,0	25,2	21,5	9,0	16,0	203	009410111
12x12	255	122	50	9,5	27,6	22,5	9,5	17,5	284	009410112
13x13	255	124	55	10,5	27,6	23,5	10,5	18,5	302	009410113

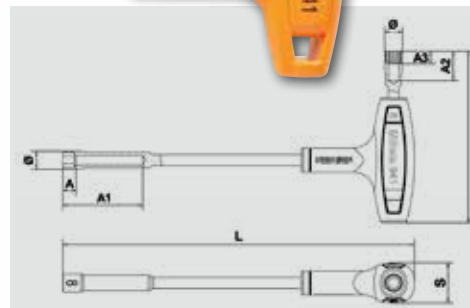

943FL

flexible hexagon nut spinners
with handles

mm	L mm	L1 mm	Ø mm	A mm	A1 mm	g	
5	265	150	8	6,0	14,0	176	009430304
5,5	265	150	8	6,5	14,0	176	009430305
6	265	150	9	6,5	14,0	178	009430306
7	265	150	11	6,5	14,0	177	009430307
8	265	150	12	6,5	14,0	179	009430308
10	290	175	14	7,5	14,0	179	009430310

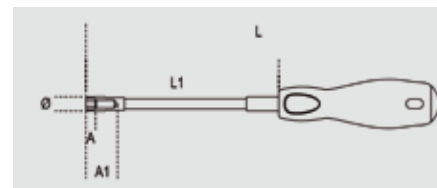

Set of flexible hexagon nut spinners with handles

943FL/S6

5-5,5-6-7-8-10 mm

1 kg 009430320



Controlled tightening



600/1

Torque angle indicators



90 mm



600/1 1/2 1/2 548 g 006000001



601C

Digital angle indicator

- For tightening screws to values set by measuring torsion angle
- Complete with buzzer and LED indicators informing user that preset angle has almost or finally been reached
- For right-hand and left-hand tightening
- Angle accuracy: $\pm 2\%$
- Resolution: 0.1°
- Up to 9 angle values can be preset
- Up to 50 measurements can be preset
- Supplied in an ABS case
- Power supply: 2 AAA-size batteries (included)



CE 601C 70 g 006010100

Click-type torque wrenches with reversible ratchets, torque accuracy: $\pm 3\%$

- scale increased by 60% for improved visibility and setting accuracy
- torque adjusting speed increased by 40%
- handle and lens materials resistant to all chemical substances used in automotive sector, industry and aviation
- red colour of o-ring indicates that wrench is unlocked and torque can be adjusted
- when not in use, set torque to lowest value of torque wrench range
- recalibration reminder shows time to recalibrate wrench (4 steps: 3, 6, 9 and 12 months)



666N

FOR RIGHT-HAND TIGHTENING

UNI EN 26789 ISO 6789

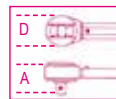

	Nm	Kgfm	lbf.in	■	D mm	A mm	L mm	g	
666N/2	5÷25	0,5÷2,5	4÷18	1/4	25	29	215	300	006660002
666N/5	10÷50	1÷5	7÷37	3/8	30	33	312	660	006660005
666N/10	20÷100	2÷10	15÷75	3/8	30	33	381	730	006660010
666N/20	40÷200	4÷20	30÷150	1/2	40	43	470	1010	006660020
666N/30	60÷300	6÷30	50÷220	1/2	40	43	598	1380	006660030



667N/30

FOR RIGHT-HAND AND LEFT-HAND TIGHTENING

UNI EN 26789 ISO 6789

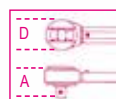

	Nm	Kgfm	lbf.in	■	D mm	A mm	L mm	g	
667N/30	60÷300	6÷30	50÷220	1/2	40	43	598	1380	006670030



1430/S5

Set of tapered extractors for broken right-hand screws and studs, in plastic case

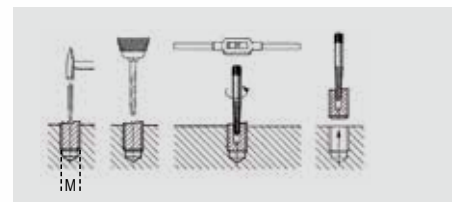

1430/S5 M3-M18 133 g 014300105



1433/C11

Set of 11 roller stud extractors with 1/2" female square and hexagon drives in metal case with soft thermoformed tray



3/8" 12"

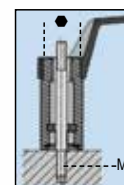

340x135x56 mm 1433/C11 M5 - M6 - M7 - M8 - M9 - M10 - M10,5 M11 - M12 - M14 - M16 19mm (M5) 21 mm (M6-M12) 24 mm (M14-M16) 3,0 kg 014330311



1500N

Universal pullers with 2 sliding legs

- The leg is so designed as to be automatically locked under loading conditions.
- Suitable for both outdoor and indoor use.
- Legs can be moved along crosspiece.

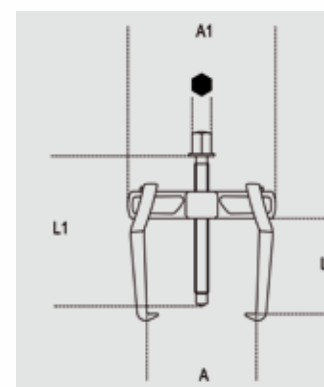

	A min=Max mm	L mm	L1 mm	● mm	A1 mm	g	
1500N/0	18÷65	70	100	15	110	400	015000600
1500N/1	23÷70	100	130	17	130	700	015000601
1500N/2	23÷100	100	130	17	160	800	015000602
1500N/3	35÷140	150	190	20	230	2200	015000603
1500N/4	35÷190	150	190	20	280	2400	015000604
1500N/5	43÷250	205	295	27	360	5700	015000605
1500N/6	43÷320	205	295	27	430	6200	015000606



1535/C...

Puller kits
in metal case

- Combination of pullers 1533, extensions 1533PR and separators 1534.
- For use where legged pullers would damage workpiece.



1535/C1	2,5 kg	015350001
☞ 260x180x40 mm		
	L mm	A min+max mm
1533/2	150	45+130
1533PR/1	100	
1534/1	88	5+60

1535/C2	2,8 kg	015350002
☞ 260x180x40 mm		
	L mm	A min+max mm
1533/2	150	45+130
1533PR/1	100	
1534/2	118	12+75

1535/C3	8,0 kg	015350003
☞ 380x280x55 mm		
	L mm	A min+max mm
1533/3	210	85+225
1533PR/2	100	
1534/3	118	22+115

1535/C4	14,8 kg	015350004
☞ 420x380x65 mm		
	L mm	A min+max mm
1533/4	175	80+310
1533PR/3	100	
1534/4	205	25+155

1535/C5	27,4 kg	015350005
☞ 530x510x85 mm		
	L mm	A min+max mm
1533/5	235	145+370
1533PR/3	100	
1534/5	290	30+220



1545/C5M

Puller 1542/1
with 5 extractors 1544
in metal case

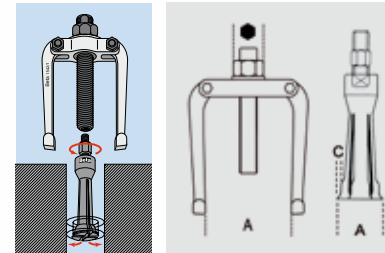

	A mm	C mm
1544/1	9+12	0,80
1544/2	13+17	1,15
1544/3	16+21	1,70
1544/4	20+25	1,65
1544/5	25+30	2,00

1542/1	2,4 kg	015450011
☞ 265x180x45 mm		

Maintenance



31/B6

Set of 6 pin punches
in wallet



31/B6	509 g	000310020
☞ 2-3-4-5-6-8 mm		

General tools



99SQ

Hook wrenches with square noses for ring nuts



	⌀ mm	S mm	L mm	B mm	⚖ g	📦
99SQ 15-35	15-35	5,1	168	2,7	88	000990215
99SQ 35-50	35-50	6,0	208	3,5	156	000990235
99SQ 50-80	50-80	8,0	282	4,7	377	000990250
99SQ 80-120	80-120	8,3	344	6,2	667	000990280
99SQ 120-180	120-180	10,8	476	7,8	1400	000990290

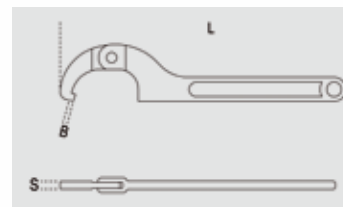

437U/09

Assortment for repairing damaged threads

M5X0,8
M6X1,0
M8X1,25
M10X1,5
M12X1,75



370x230x55 mm



25x M5, M6, M8, M10
10x M12

	⚖	📦
437U/09 M5X0,8 - M6X1,0 M8X1,25 - M10X1,5 M12X1,75	2,7 kg	004370550



437C

Set for repairing damaged spark plug threads, M14x1.25 mm

• Helicoids height: 8.40 - 12.40 - 16.40 mm
(5 pcs/size)



M14 x 1.25 mm	📏	📏	📏
	8.40	12.40	16.40
	5x	5x	5x

	⚖	📦
437C	1,1 kg	004370100



1254

Circuit testing screwdriver 6÷24V



	SxAxL mm	L mm	⚖	📦
1254	0,5x3x44	123	30 g	012540001



1295/C14

Impact screwdriver
with 14 insets
and 1 socket holder

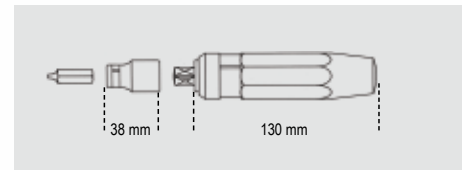

170x100x35 mm **1295/C14** 1,3 kg 012950108



1481PL/S3

Set of 3 plastic hose pliers



1481PL/S3 1481PL-A Ø 8÷15 mm 240 g 014810200
1481PL-B Ø 15÷25 mm
1481PL-C Ø 25÷45 mm



1599P

Parallel bench vices

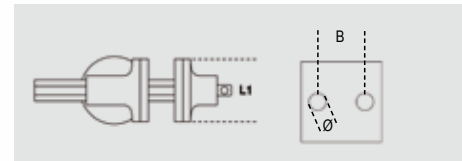

	L1 mm	B mm	Ø mm	kg	
1599P 100	100	92	11	7.3	015990000
1599P 125	125	108	13	11.5	015990025
1599P 150	150	130	15	20.5	015990050



1599G

Pairs of aluminium jaw covers

- Internally milled to lock threaded parts



	A mm	kg	
1599G 100	100	183	015990910
1599G 125	125	222	015990912
1599G 150	150	260	015990915
1599G 180	180	302	015990917

General tools



1712E/L1

Flexible magnetic pick-up tool with LED light

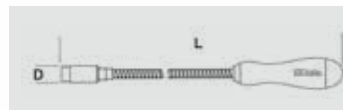

	L mm	D mm	F kg		
1712E/L1	500	11	0,75	500 g	017120111



1712E

Flexible magnetic pick up tools



	L mm	D mm	F kg		
1712E/1	420	7,5	0,5	145	017120011
1712E/2	530	15	1,8	232	017120012
1712E/3	532	19	3,0	239	017120013



1712TF

Telescopic magnet with flexible head



	L mm	D mm	F kg		
1712TF	150÷590	11	1	61 g	017120600



1737NX

Brake shoe cleaning brush plastic handle steel wires



	L mm		
1737NX	270	144 g	017370010



1737

Brush, brass wires



	L mm		
1737	145	20 g	017370001



1751

**Metal pressure oil cans
flexible spout**

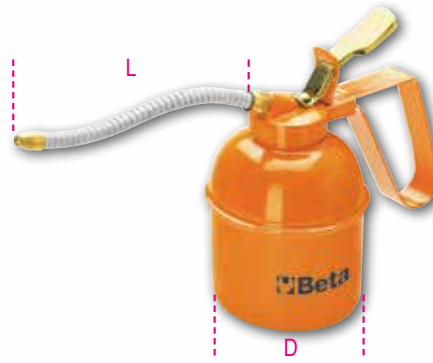

cc	D mm	L mm	g	
300	75	140	281	017510003
500	85	140	308	017510005



1753

**Plastic pressure oil cans
flexible spouts**



cc	D mm	L mm	g	
300	80	190	114	017530003
500	95	190	127	017530005



1756B

Pen oiler

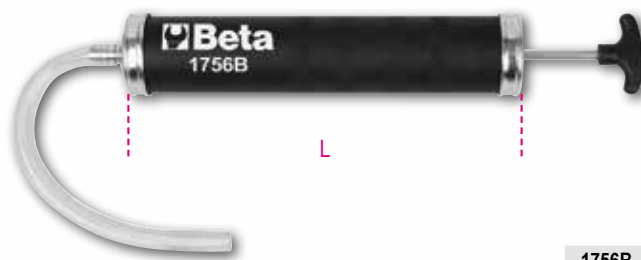

	cc	L mm	g	
1756B	500	190	820	017560220



1756C

**Suction gun, 200 ml,
made of polypropylene**

- Also suitable for braking system fluid
- Double EPDM gasket
- Operating temperature: +0 - +50 °C
- NOT suitable for fuel



	ml	L mm	g	
1756C	200	220	300	017560502



1757

Battery fillers



cc	D mm	g	
250	60	40	017570002

General tools



1761

Wire twisting pliers
with automatic return

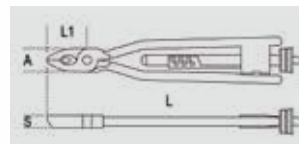

	L mm	L1 mm	A mm	S mm	Weight	Accessories
1761	255	40	21	11	300 g	017610101



1761RS/1

Reversible wire
twisting pliers
with automatic return

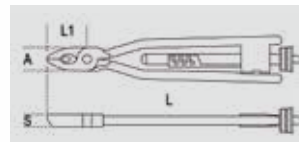

	L mm	L1 mm	A mm	S mm	Weight	Accessories
1761RS/1	220	30	15	10	250 g	017610130



1767PMR

Magnetic tool holder,
rectangular



1767PMR 017670010



1767PMC

Magnetic tool holder,
round



1767PMC 150 017670020



1835/1

LED inspection torch, made of
sturdy anodized aluminium

- 1xAAA battery (not included)
- IPX6



	L mm	Weight	Accessories
1835/1	105	33 g	018350030



1835/2

LED inspection torch, made of
sturdy anodized aluminium

- 2xAAA batteries (not included)
- IPX6



	L mm	Weight	Accessories
1835/2	145	40 g	018350060



1838/11LED

Rechargeable inspection lamp with ultra-high brightness LEDs. Lithium polymer battery

- Compact body made of antislip rubber
- Easy-to-replace front glass
- Swinging hook
- With charging station, 110-230Vac
- 320 lumens
- With multidirectional head LED



IP65 CE 1838/11LED 334 g 018380111



1838COB

Compact rechargeable inspection lamp with ultra-brightness LEDs. Lithium polymer battery

- Compact body made of antislip rubber
- Swinging hook
- Magnetic base can be rotated 180 degrees
- With charger 100-240Vac / 50-60Hz
- 55 / 110 lumens
- Operating range: 5 / 2.5 hours
- IP20



CE 1838COB 200 g 018380010



1838SL

Ultra-thin inspection lamp with ultra-high brightness LEDs. For jobs in small areas

- Power supply: 12V, with lighter socket and battery terminals
- 2.5-m-long cable
- Thickness: 6 mm
- 345 lumens



CE 1838SL 6 mm 100 g 018380101



1879

9.5 l manual/pneumatic operation fluid extractor

Suitable for: engine oil, gearbox oil, brake fluid, coolant, water etc.

- Can be used with both manual pump and compressed air
- Operating pressure: 3-12 bar
- Fluid temperature range (1-95 °C)
- Supplied with 4 nylon joints for different purposes



1879 4,9 kg 018790001



1880

Manual barrel pump

- For nonaggressive oil and fluids
- Do not use with aqueous fluids, acid solvents, Diesel oil, petrol and the like
- Complete with barrel connection, telescopic tube and delivery spout



1880 240 gr 2,4 kg 018800001



1850B

Heat gun

- Pos. 1 240 l/min. 300° C
- Pos. 2 450 l/min. 500° C
- Can be used with gun placed vertically on worktop



	L mm	H mm	W mm	°C	V	l/min	kg	018500011
1850B	240	190	1600	300-500	230	240/450	1 kg	018500011



446/C30

Assortment of chrome-steel taps and dies, metric thread, and accessories in wooden case



430 M mm	440 M mm		
3x0,5	3x0,5	435/1,5	444/1
4x0,7	4x0,7		
5x0,8	5x0,8		
6x1	6x1		
8x1,25	8x1,25		
10x1,5	10x1,5		
12x1,75	12x1,75		

370x230x55 mm **446/C30** 1,2 kg 004460055



1851VK

Hot glue gun with 12 thermofusible glue sticks in case

- Ø 11 and 12 mm
- Power: 80 watt



320x250x50 mm **CE** 1851VK 600 g 018510058





960P

Pressure/depressure tester
with accessories and adaptors



370x230x55 mm

960P

1,9 kg

009600777



1760PA/80

AC/DC amperometric clamp, 80A
Specifically designed to measure
low current leakage or absorption
values on vehicles

- Range: 1 mA-80A AC/DC
- Torch function with white LED
- Backlit LCD display
- Zero setting function
- Hold function
- Auto power off
- Power supply: 2 1.5V AAA-type batteries



CE

1760PA/80

270 g

017600002



1760B

Digital multimeter

SPECIFICATIONS

DC voltage: 200 mV-2/20/200/1000V

AC voltage: 2-20/200/700V

DC current: 2/20/200 mA-20 A

AC current: 2/200 mA- 20 A

Resistance: 200Ω - 2/20/200 kΩ - 2/20 MΩ

Capacity: 2/20/200 nF - 2/200 μF

Temperature: -20° + 1000°C/ -4 °F ~ +2000°F

Frequency: 20kHz

Power supply: 1 9V battery (included)



CE

1760B

670 g

017600012



1760/TC2

Combination contact/non-contact digital tachometer

TECHNICAL DATA

- For measuring:
 - non-contact rotational speed (rpm)
 - contact rotational (rpm) and linear surface speed (m/min or ft/min).
- 5-digit LCD display.
- Scale:
 - non-contact speed 2.5÷99,999 rpm
 - contact speed 0.5÷19,999 rpm
 - linear surface speed 0.05÷1,999.9 m/min.
- Frequency: 0.8 sec.
- Power supply: 4 1.5V batteries, AA size, or 6V power supply unit (not included).



Supplied with the following:

- adaptor for contact tip measurement;
- male (contact) rubber tip (2 pcs.);
- female (contact) rubber tip (1 pcs.);
- linear measurement tape (1 pcs.);
- reflecting tapes;
- instruction manual;
- plastic case.

CE	1760/TC2	L	H	570 g	017600161
		mm	mm		



1760/IR800

Digital infrared thermometer with dual laser aiming system

TECHNICAL DATA

- Range: -50 °C to +800 °C / -58 °F to +1472 °F
- Scale selection: °C/°F
- Accuracy: ±1.0% or ±1.0 °C to 20 °C
- Laser power: <1 mW
- Response: 150ms
- Emissivity: 0.10-1.0 adjustable
- Distance ratio: (D:S) 20:1
- Operating temperature: 0 °C ÷ 50 °C / 32 °F ÷ 122 °F



- Operating humidity: 10% to 90% RH
- Backlit LCD display
- Data storage function
- Auto power off
- Power supply: 1 9V battery (included)
- Soft cloth case (included)
- Operating manual

CE	1760/IR800	L	H	350 g	017600380
		mm	mm		



"Photo Milagro"

Engine



955

Tubular spark-plug wrench
chrome-plated, hexagon end

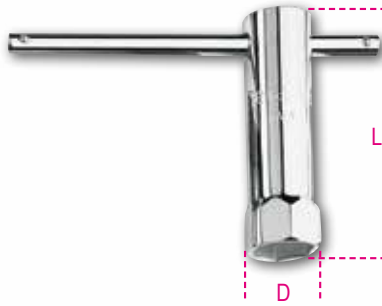

mm -"	D mm	L mm	g	
16 5/8	21	86	140	009550016
20,8 13/16	29	86	190	009550021



956C

1/2" square drive spark
plug sockets chrome-plated,
hexagon ends

12" ISO 11168



mm -"	Ø mm	L mm	g	
14 9/16	18,8	70	95	009560008
16 5/8	21,4	70	105	009560010
17,8 11/16	23,6	70	140	009560011
20,8 13/16	27,0	70	160	009560012



956L

1/2" square drive spark
plug sockets, bi-hex ends,
long series

12"

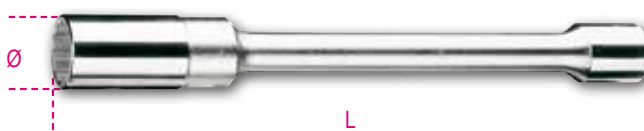

mm -"	Ø mm	L mm	g		mm -"	Ø mm	L mm	g	
14 9/16	20,2	250	370	009560214	17,8 11/16	24,0	250	430	009560217
16 5/8	24,0	250	375	009560216	20,8 13/16	28,5	250	430	009560221



957

T-handle spark plug wrenches
with swivelling sockets

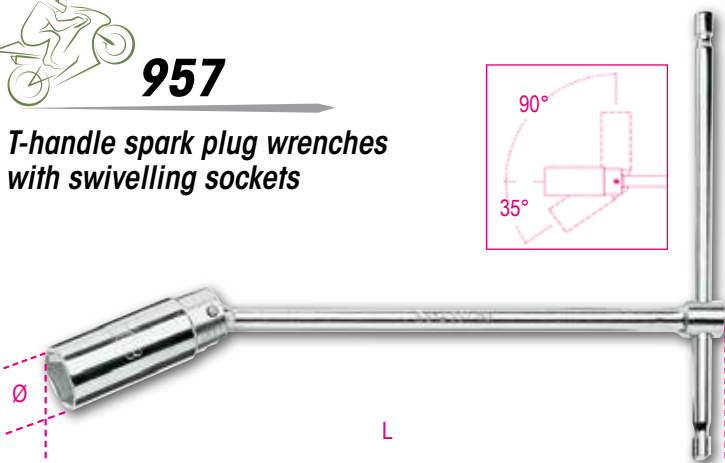

ISO 11168

mm -"	Ø mm	L mm	g	
16 5/8	21,4	275	300	009570000
20,8 13/16	27,0	275	340	009570001



1440

Piston ring compressors



	Ø mm	D mm	g	
1440/0	40÷75	50	140	014400000
1440/1	57÷125	80	250	014400010
1440/1A	57÷125	100	300	014400011



1445/1

Piston ring expanders



1445/1	∅ mm 50÷100	200 g	014450001



1450GC

Valve spring compressor with straight and offset jaws

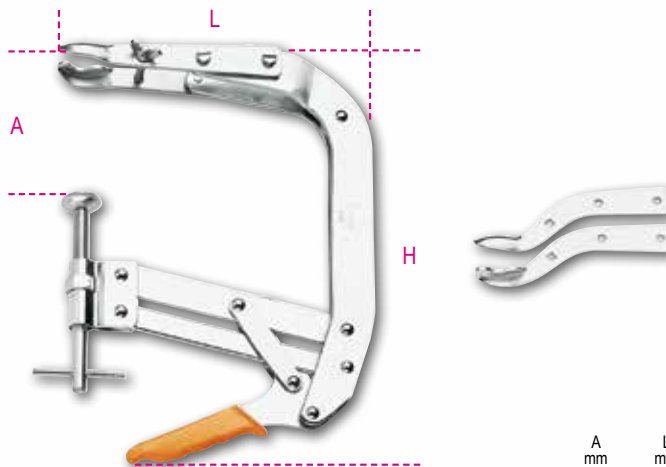

1450GC	A mm 45÷225	L mm 205	H mm 300	1,6 kg	014500005



1474L

Spark-plug pliers, curved long nose, 15°

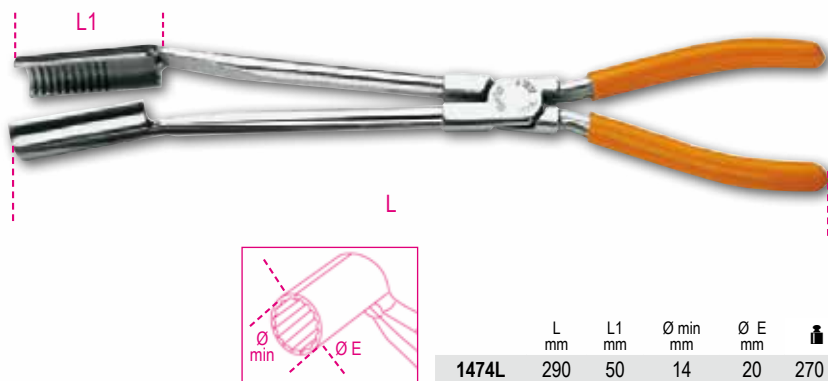

1474L	L mm 290	L1 mm 50	∅ min mm 14	∅ E mm 20	270 g	014740010



1474DL

Spark-plug pliers, long nose, double layer PVC coated handles

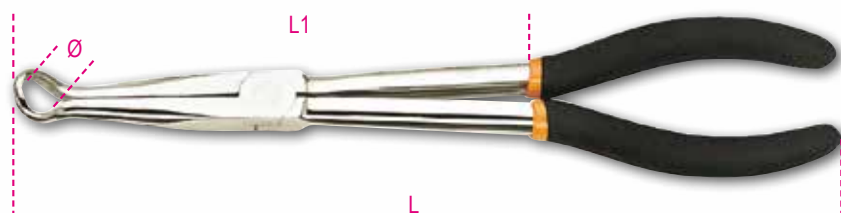

1474DL	L mm 275	L1 mm 170	∅ mm 12	310 g	014740015



1708/8

Metric feeler gauges

- Steel blades with rounded ends.
- Locking screw.
- Thicknesses in mm/inches.



	S mm	S "	L mm	Weight	Code
1708/8	0,05÷0,50	0,002÷0,020	105	35 g	017080008



1439/K7

Angular screwdriver (90°), long series, with blades, in case

Case contents:

- Angular screwdriver
- 1 slotted screw head
- 1 1/4" bit head
- Special blade head
- 7 special blades

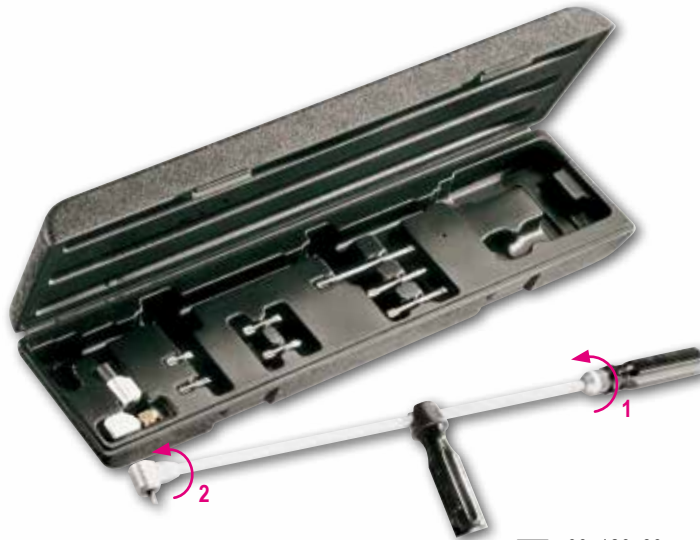

	Dimensions	Code	Weight	Code
1439/K7	500x120x60 mm	1439/K7	1 kg	014390101



1410/M

Spring pulling hook wrench



	L mm	Ø mm	Weight	Code
1410/M	155	3,5	50 g	014100051



1490/1

Strap wrenches for oil filters

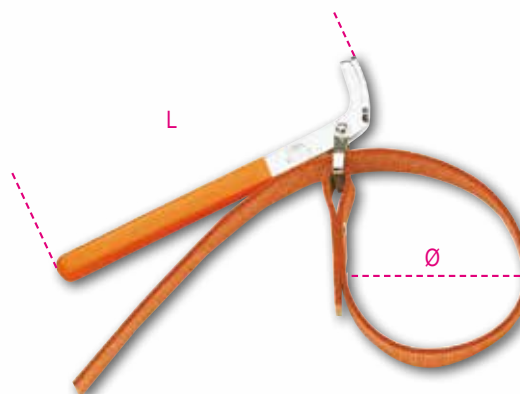

	Ø max mm	L mm	Weight	Code
1490/1	160	225	290 g	014900001



1493T

Self-adjusting oil filter wrench
with three arms
for left-hand tightening



	Ø mm	g	
1493/T	60÷120	610 g	014930075



1493Z

Self-locking
oil filter wrenches,
right-hand

12"



	Ø mm	g	
1493Z/1	60÷80	410	014930090
1493Z/2	80÷100	710	014930095
1493Z/3	100÷125	1000	014930100



1493

Oil filter wrench

12"



	Ø mm	N	g	
1493 65-L14	65	14	120	014930200
1493 68-L14	68	14	140	014930206
1493 73-L14	73	14	151	014930208
1493 74-L14	74	14	142	014930209
1493 74-L15	74	15	151	014930210
1493 75/77-L15	75-77	15	161	014930212
1493 76-L8	76	8	147	014930214
1493 76-L14	76	14	170	014930218
1493 76-L15	76-74	15	183	014930220
1493 78-L15	78	15	161	014930224
1493 80-L15	80	15	163	014930226
1493 82-L15	82-80	15	192	014930228
1493 86-L16	86	16	234	014930230
1493 90-L15	90	15	204	014930234
1493 92-L10	92	10	192	014930236
1493 93-L15	93	15	209	014930238
1493 95-L15	95	15	198	014930244
1493 100-L15	100	15	253	014930248
1493 106-L15	106	15	245	014930250
1493 108-L15	108	15	247	014930252
1493 135-L18	135	18	571	014930256



1878 11

Fluid collection tank

- Maximum capacity: 11 l
- Fluid drain plug
- Interior wall for preventing fluid leakage during transportation



	g	
1878 11	850 g	018780011



1498/2A

Electronic motorcycle battery charger, 12V

Allows charging of all Pb Wet, Agm, Gel, Mf and Vrla battery types and LiFePo4 lithium batteries

- Two different types of charge, for lithium and lead acid batteries respectively
- Automatic multi-stage charge cycle
- Reverse polarity and short-circuit protection
- IP65 degree of protection
- Complete with cable with clamps and cable with eyelets
- Power supply voltage: 220-240V



- TECHNICAL DATA**
- Charging current: 1A
 - Charging capacity: 2Ah-40Ah
 - Frequency: 50-60 Hz
 - Battery voltage: 12V
 - Dimensions: 180x80x40 mm

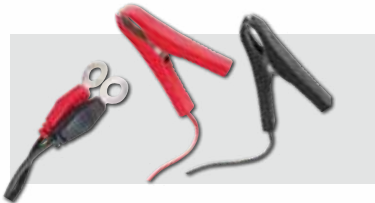

IP65



1498/2A 500 g 014980102



1498/4A

Electronic car/motorcycle battery charger, 6-12 V

- Protected against polarity reversal and short circuits
- Automatic 6 V or 12 V selection
- Automatic battery type selection
- Digital backlit display
- Pull-back fixing hook
- Complete with cable with clamps and cable with eyelets



- TECHNICAL DATA**
- Power supply voltage: 220V-240V
 - Frequency: 50-60 Hz
 - Rated current (min-max): 1-4 Amp
 - Battery voltage: 6V/12V
 - Battery capacity: 4Ah-80Ah
 - Charging time: 12 hours
 - Degree of protection: IP65



IP65



1498/4A 950 g 014980104



1498CM/12

Portable motorcycle emergency starter

3 functions in 1:

- Starter
- Additional battery for electronic devices (tablets, smartphones etc.)
- High-brightness LED torch

Equipment:

- Starting cable with insulated clamps and protection diode
- Mains battery charger
- Car battery charger
- USB cable with charge adapters



TECHNICAL DATA

- Starting current: 200A
- Peak current: 400A
- USB outlet: 5V 2,1A
- Dimensions: 130x50x15 mm

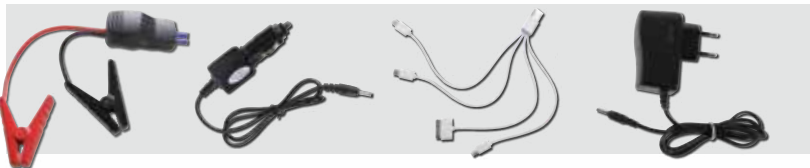

CE 1498CM/12 300 g 014980030





1568/C15

Chain opening
and riveting kit

Ø 3-4-5 + Regina kit



420x185x60 mm 1568/C15 2 kg 015680015



3081

Portable chain tool

Sturdy and foldable, easily fitting into enduro tool bags.

Suitable for chain sizes 415, 420, 428, 520, 525, 530



L mm 3081 124 282 g 030810010



1467

Brake fluid extractor

Pressure: min 5 bar, Max 11,5 bar



1467 1,5 1,5 kg 014670001



3085

Tool for retracting brake pistons

Suitable for motorcycle and scooter brake callipers

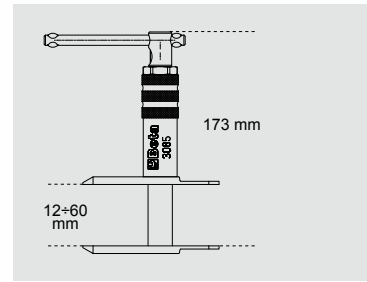

3085 694 g 030850010



3073

Universal fork oil seal driver fitting tool

For fork tube diameters 43 a 48 mm

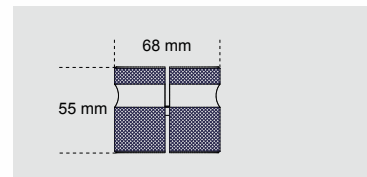

3073 221 g 030730001



3072

Mechanical screw spring disassembly tool for single shock absorber and forks

Includes flange adapter kit:
74-45-47-50-53-56-59-62-68-
71-75-77-80-84-87 mm

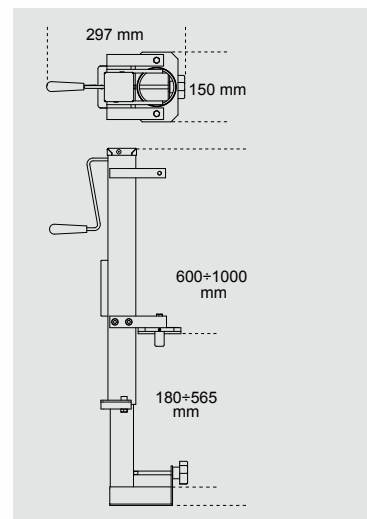

3072 18 kg 030720001

Wheels



962

Tyre levers



L mm	A mm	g		L mm	A mm	g	
300	21	300	009620003	500	27	750	009620005
400	25	450	009620004	600	27	1000	009620006



986 48

Tyre valve screwdriver, short model

Particularly suitable for small diameter tyres, e.g. scooter tyres

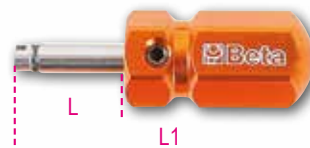

	L mm	L1 mm	g	
986 48	18	48	16 g	009860048



986 78

Tyre valve screwdriver

Automatic valve retention



	L mm	L1 mm	g	
986 78	18	78	32 g	009860078



1949DGT

Digital tyre inflator

- Operating pressure: 0÷11 bar (2.0÷160 psi)
- 4 units of measurement: psi/bar/kgcm²/kpa
- Backlit LCD display
- Reset feature
- Self-power off after 3 min.
- Pressure release button
- Resolution: 0.05 bars
- ABS housing, protective rubber shell on gauge, shockproof, nonslip handle grip
- Power supply: 2 AAA size 1.5V batteries
- Compatible with coupling 1916G 1/4"

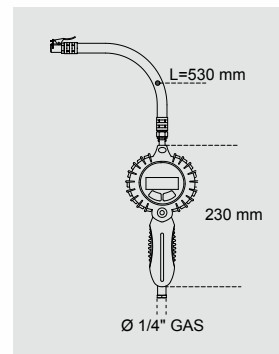

	bar	g	
CE 1949DGT	0÷11	500 g	019490020



1949GPE

Tyre inflator

- Operating pressure: 0÷11 bars (10÷160 psi)
- Pressure release feature
- Pressure measurement feature
- Gauge coated with shockproof rubber
- 360 degree hose rotation

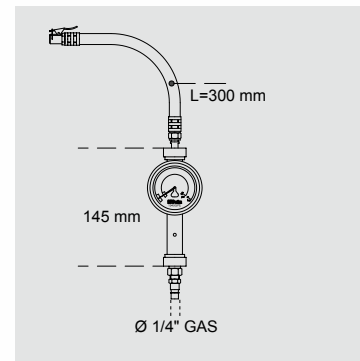

	bar		
1949GPE	0÷11	640 g	019490008



1949M

Tyre pressure tester

- Reading pressure: 0÷4 bars (5÷60 psi)
- Accuracy: 0.1 bars (1.0 psi)
- Pressure measurement feature
- Pressure release feature
- Gauge coated with shockproof rubber
- Hose length: 350 mm



	bar		
1949M	0÷4	280 g	019490400



1949T

Telescopic progressive blow gun

- Hard-wearing, shockproof composite material body
- Telescopic steel swivel tube: 165 mm ÷ 300 mm

TECHNICAL DATA

- Aluminium threaded insert: 1/4" GAS
- Operating pressure: 6÷8 bar
- Maximum operating pressure: 15 bar
- Mean air consumption: 144 l/min
- Operating temperature: -20°C ÷ 70°C

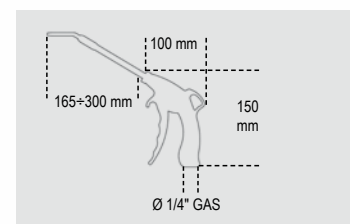

1949T	190 g	019490040

Wheels



3070

Manual static balancer

- Allows wheel balancing both in the workshop and on racing tracks
- Equipped with rolling bearings, rabbet level and adjustable feet for unparalleled precision
- Comes with 2 hub cones
- Dimensions: 480x285x490 mm



3070 9,5 kg 030700000



3070/1

Rim truing kit, for item 3070



3070/1 200 g 030700001



3070/2

Adapter kit for single-arm wheels, for item 3070



3070/2 300 g 030700002



3070/3

Universal adapter kit for scooters, for item 3070

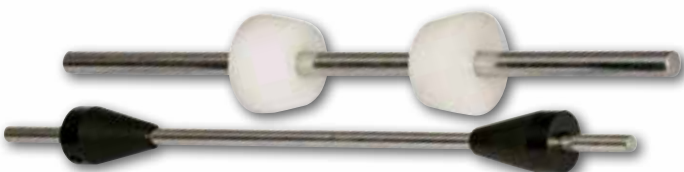

3070/3 1 kg 030700003



3070/4

Adapter kit for BMW motorcycles, for item 3070



3070/4 300 g 030700004



3075/K10

Set with a universal wrench with interchangeable head and 10 bits, for tightening wheel spokes



133x103x30 mm **3075/K10** 231 g 030750410



3075A

Hexagon socket for wheel hub nuts

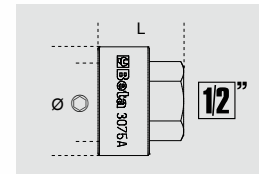

Ø mm	Ø mm	L mm	g	
28	38	30	47	030750028
30	40	30	49	030750030



3075B

Bi-hex socket for wheel hub nuts

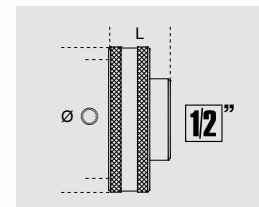

Ø mm	Ø mm	L mm	g	
55	70,7	25	155	030750155



3075/CM

Multiple hexagon socket for wheel pins

Sizes: 12-14-17-19-22-24 mm



3075/CM 34 g 030750212

Stands and jacks



3041

Front motorcycle stand adjustable



3041 2,5 kg 030410001



3040

Rear motorcycle stand adjustable



3040 2,5 kg 030400001



3041A/11

Roller sliders, pair for item 3041



3041A/11 500 g 030410511



3040A/1

V-shaped sliders, pair for item 3040



3040A/1 1 kg 030400501



3041A/15

Cone-shaped sliders, pair for item 3041



3041A/15 500 g 030410515



3040A/2

L-shaped sliders, pair, made of rubber for item 3040



3040A/2 850 g 030400502



3040A/6-8-10

Pawls, pair, made of aluminium for item 3040A/1



3040A/6	M6x1 mm Aprilia, Yamaha, Triumph	030400506
3040A/8	M8x1.25 mm Suzuki, Honda, Ducati	030400508
3040A/10	M10x1.25 mm Kawasaki	030400510





3042

Front stand for motorcycle steering pin

- Matt black lacquer
- 4 thermoplastic rubber wheels
- Includes a 6-pin kit
Ø 13 - 14 - 16 - 20 - 26,5

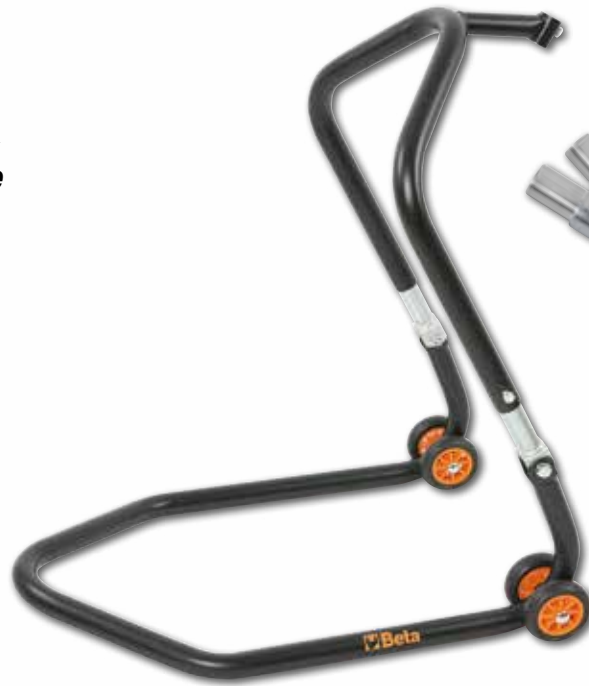

3042 4 kg 030420001



3043

Motorcycle stand with LEFT single arm

Motorcycle stand with single arm

- Matt black lacquer
- Steel slider holder
- 4 thermoplastic rubber wheels



3043 3 kg 030430001



3044

Motorcycle stand with single RIGHT arm



3044 3 kg 030440001



3043A

Pin for item 3043



		Ø mm	g	
3043A/41	Ducati	21,8	600	030430541
3043A/42	Triumph	27,5	600	030430542
3043A/43	MV - Ducati	42	600	030430543
3043A/44	Ducati 1098	40	600	030430544
3043A/45	Honda	28,6	600	030430545
3043A/46	BMW F800S	30	600	030430546
3043A/47	BMW K,R,S	52,9	600	030430547
3043A/48	Honda CB1000R	28,3	600	030430548



3044A/41

Right pin for Ducati 848



		Ø mm	g	
3044A/41	Ducati 848	29,6	600 g	030440541

Stands and jacks



3047

Pedal stand for cross/enduro motorcycles

Dimensions:

- Minimum height: 290 mm
- Maximum height: 400 mm
- Support: 300x150 mm



3047 7,5 kg 030470001



3048

Aluminium racing cross stand

Dimensions

- Height: 410 mm
- Support: 300x220 mm



3048 2,5 kg 030480001



3050/C

Chock cradle centre stand for Custom, Enduro, Cross, Scooter motorcycles

Includes adjustable support and rubber pad kit



- Technical features:
- Minimum height: 90 mm
 - Maximum height: 310 mm
 - Capacity: 350 Kg
 - Lifting height: 220 mm
 - Column height: 130 mm
 - Dimensions: 510x210x170 mm

3050/C 18 kg 030500011



3050/CL

Chock cradle centre stand, wide type

Technical features:

- Minimum height: 90 mm
- Maximum height: 370 mm
- Capacity: 350 kg
- Lifting height: 280 mm
- Dimensions: 510x300x90 mm

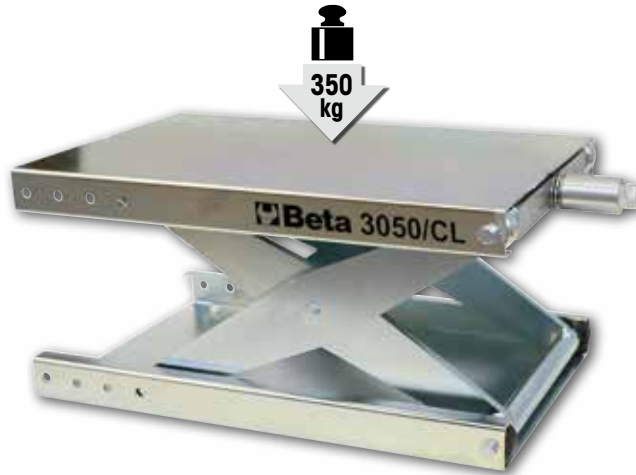

3050/CL 28 kg 030500021



3053

Motorcycle stand base with non-slip rubber cover

- For use with all motorcycles and scooters with central stands
- With 4 polyurethane swivel castors, 2 with brakes
- Allows motorcycles to be moved in all directions, thereby making it easier to park them in small areas in garages
- Extension for side stand available (3053/E)
- Dimensions: 450x460x80 mm



3053 8,5 kg 030530001



3053/E

Extension item 3053 for side stand

- To connect to base item 3053
- Dimensions: 855x140x80 mm



3053/E 6 kg 030530002



Stands and jacks



3050/K

**Electro-hydraulic motorcycle jack,
600 kg**

Technical features:

- Electrical, mechanical and hydraulic safety devices
- Capacity: 600 kg
- Integrated electro-hydraulic unit: 1.1 kW - 230V - 7.4A - 50 Hz
- Hydraulic pump with an upward flow rate of 2 l/min
- Downward speed controlled by a flow valve, 1 l/min
- Safety valve stopping oil flow in case hydraulic pipe should be accidentally cut
- Can accommodate a hand control device with a 3-m-long cable
- Pins mounted on self-lubricating bushings
- Piston seal lubricated during each cycle, for longer life
- Jack with 7 mechanical safety positions
- CE-certified, TÜV-approved

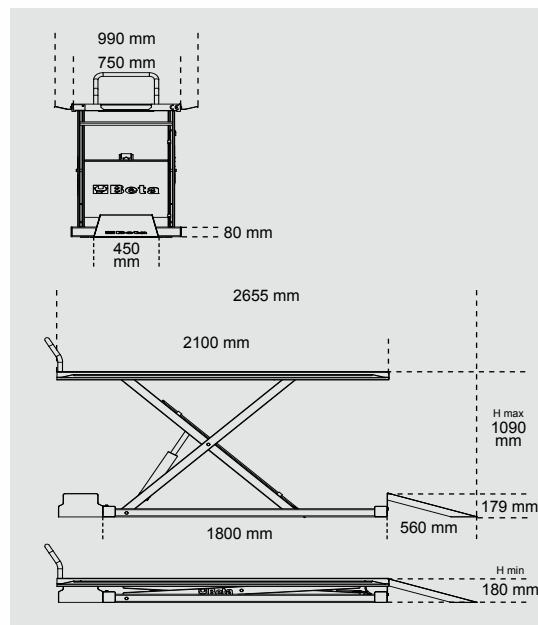

	Weight	Code
	3050/K-O 180 kg	030500101
	3050/K-G 180 kg	030500102
	3050/K-R 180 kg	030500103

CE



Run-up ramp



Side tools holders



Gate 60x35 cm



Front safety bar



3050/K2

Widening kit for jack
item 3050/K



	Weight	Code
3050/K2-O	60 kg	030500121
3050/K2-G	60 kg	030500122
3050/K2-R	60 kg	030500123



3050/M

Mechanical wheel clamp
for jack item 3050/K



Code	Weight	Code
3050/M	16,5 kg	030500031



3051/LA

Non-slip sheet metal top
for jack item 3050/K

Dimensions: 540x340 mm



Code	Weight	Code
3051/LA	1,6 kg	030510061

Specialized equipment



3055

Automatic van clamp

Allows motorcycle front wheel to be fixed



3055 8,7 kg 030550001



3057

Aluminium ramp for loading/unloading motorcycles

Dimensions: 1820x300 mm



3057 6,4 kg 030570001





3079/21

Cable oiler

Allows proper lubrication of clutch cables and gas control, for increased sheath smoothness and cable duration.



3079/21 40 g 030790021



3091

Flywheel pullers with internal thread



	M	
3091/10	24x1,5	030910010
3091/20	26x1,0	030910020
3091/30	28x1,0	030910030
3091/40	30x1,0	030910040
3091/45	30x1,5	030910045
3091/50	32x1,5	030910050
3091/60	33x1,5	030910060
3091/70	35x1,0	030910070
3091/75	35x1,5	030910075
3091/80	38x1,5	030910080



3092

Flywheel pullers with external thread



	M	
3092/10	18x1,5	030920010
3092/20	19x1,0	030920020
3092/30	27x1,25	030920030
3092/35	22-26x1,5	030920035
3092/40	25x1,5	030920040
3092/50	26-28x1,0	030920050
3092/60	28x1,5	030920060



3093/E

Tool for locking flywheel, clutch bell and pulleys



3093/E 1 kg 030930100



3093/U

Multiple flywheel puller

Sizes:
M10x1.25R
M14x1.5R
M16x1.5R
M18x1.5R
M24x1.0R
M27x1.0L



3093/U 700 g 030930050

Tie down systems



8188F

Cam buckle straps,
LC 200 kg, high-grade
polypropylene (PP) belt

EN 12195-2



	L m	g	
8188F 1,5	1,5	56	081880215
8188F 2,5	2,5	72	081880225
8188F 5	5	110	081880250



8188C

Ring ratchet tie downs,
LC 750 kg, high-tenacity
polyester (PES) belt

EN 12195-2



	L m	g	
8188C	5	323 g	081880350



8188CG/25

Ratchet tie downs
with S-hooks and Eyes,
LC 375 kg high-tenacity
polyester (PES) strap

EN 12195-2

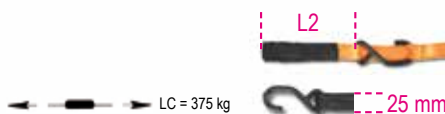
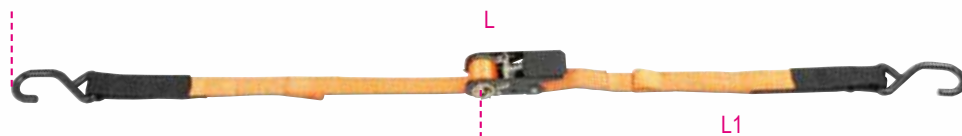

	L m	L1 mm	L2 mm	g	
8188CG/25 3	3	480	170	475	081880430
8188CG/25 5	5	480	170	519	081880450



8188VFG2

Cam buckle strap
with S-hooks and Eyes,
LC 250 kg high-grade
polypropylene (PP) belt

EN 12195-2

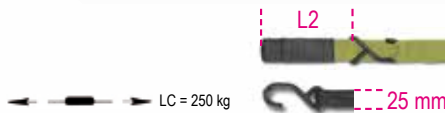

	L m	L1 mm	L2 mm	g	
8188VFG2 3	3	450	110	418 g	081881530



8130A

Chains with ring for padlock, case-hardened, tempered, galvanised

- Alloy steel, hardened and tempered to counteract the manual sawing.
- High-quality electroplating.
- Covered with textile tube: it minimizes the encumbrance and prevents scratches.

AVAILABLE CERTIFICATES

- Test report UNI EN10204 type 2.2

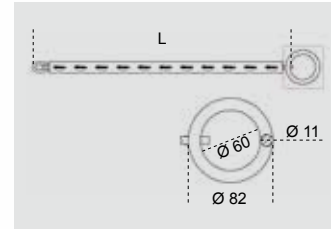

	Ø mm	L mm	kg	
8130A	10	900	1,9	081300209



Included in the package:

- Transport bag
- 3 keys
- High visibility lock-reminder cord



8139DL

Motorcycle disc lock, made of alloy steel, tempered, covered with scratch-resistant PVC sheath

- 14 mm alloy steel locking shackle, hardened and tempered, covered with scratch-resistant pvc sheath
- Cut resistant, impact resistant, weather resistant
- Protective cap for the lock
- For chain links 10 mm (min.).

AVAILABLE CERTIFICATES

- Test report UNI EN10204 type 2.2

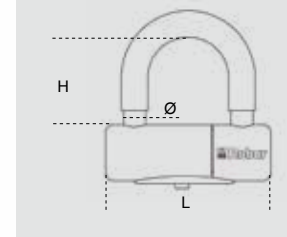

	Ø mm	L mm	H mm	g	
8139DL	14	108	56	600	081390214



8130

Antitheft chains, made of alloy steel, case-hardened, tempered, galvanised

- Alloy steel with "D" shape links, hardened 57-60 HRC to counteract the manual sawing.
- High-quality electroplating
- Covered with textile tube: it minimizes the encumbrance end prevents scratches.

AVAILABLE CERTIFICATES

- Test report UNI EN10204 type 2.2

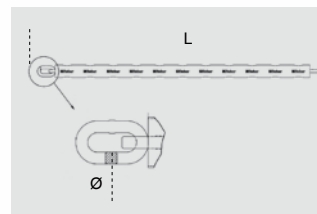

	Ø mm	L mm	kg	
8130 6X800	6	800	0,58	081300068
8130 8X1000	8	1000	1,47	081300081
8130 8X1200	8	1200	1,67	081300082
8130 10X1500	10	1500	3,15	081300105



8139Z

Padlocks with steel shackle, zinc alloy body

- Corrosion resistant
- 10mm double locking shackle
- Safety punched keys
- Cut resistant / impact resistant
- For 6 and 8 mm chains

AVAILABLE CERTIFICATES

- Test report UNI EN10204 type 2.2

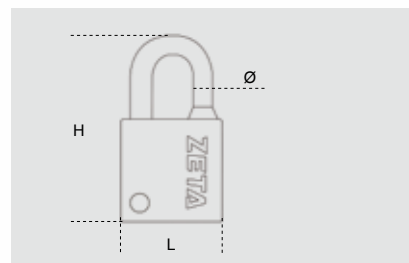

	Ø mm	L mm	H mm	kg	
8139Z	10	55	98	400 g	081390009



8139ZCH

N°3 blank spare keys, item 8139Z

- Duplicable by punching machine



8139ZCH	081390909
---------	-----------



Beta **R S C 5 5**

Configure your workshop online
www.beta-tools.com/RSC55en

360°
view





Beta

Beta Utensili S.p.A.
 Via A. Volta 18
 20845 Sovico (MB)
 Tel. 039.20771
www.beta-tools.com

SPEEDUP
Racing Sport

Simone Corsi
 Moto2 World Championship

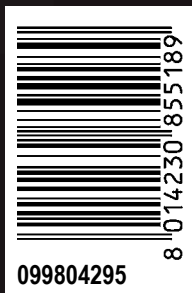

099804295